



# 4-channel/2-channel Power Amplifier

## Amplificateur de puissance à 4 ou 2 canaux

# P2040

OPERATION MANUAL  
MODE D'EMPLOI

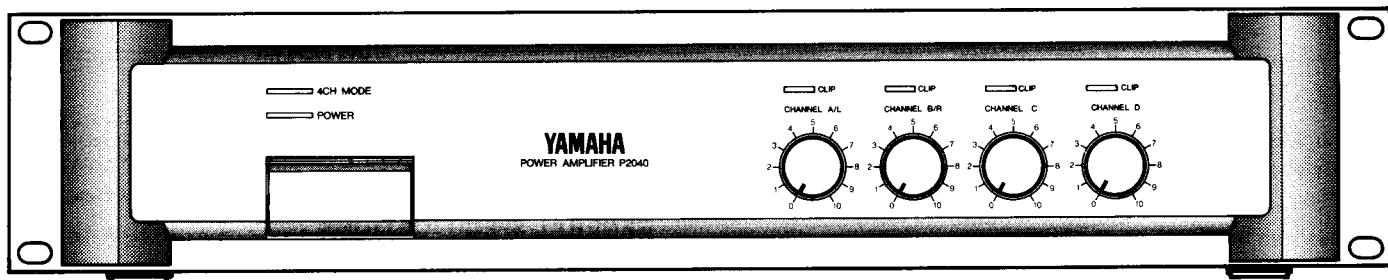

## INTRODUCING THE P2040

*The Yamaha P2040 has four completely independent power amplifier channels that deliver up to 20 watts RMS into 8-ohm loads. If you have an application that doesn't require all four channels, flipping a rear-panel switch instantly shifts the P2040 into the 2-channel mode providing a stereo power amplifier which puts out 40 watts RMS per channel into 8-ohm loads. Independent level controls are provided on all four channels for precise, easy level balancing, and independent clip-indicator LEDs warn of excessively high levels that may cause distortion. If you have an application that requires four channels of power amplification, the P2040 saves the expense and confusion of having to purchase and set up dual stereo amplifiers, or if your application requirements vary and you need a versatile system of utility power amplifiers the P2040 offers everything you need. We urge you to read this operating manual thoroughly before using the P2040 in order to take full advantage of its superior performance capabilities.*

---

### CONTENTS

---

PRECAUTIONS .....	2
OPERATION .....	3
MOUNTING .....	5
GENERAL SPECIFICATIONS .....	6
BLOCK DIAGRAM .....	7
DIMENSIONS .....	7

# PRECAUTIONS

## 1. AVOID EXCESSIVE HEAT, HUMIDITY, DUST AND VIBRATION

Keep the unit away from locations where it is likely to be exposed to unusually high temperatures or humidity. Also avoid locations which are subject to excessive dust accumulation or vibration which could cause mechanical damage.

## 2. AVOID PHYSICAL SHOCKS

Strong physical shocks to the unit can cause damage. Handle it with care.

## 3. DO NOT OPEN THE UNIT OR ATTEMPT REPAIRS OR MODIFICATIONS YOURSELF

This product contains no user-serviceable parts. Refer all maintenance to qualified Yamaha service personnel. Opening the unit and/or tampering with the internal circuitry will void the warranty.

## 4. MAKE SURE POWER IS OFF BEFORE MAKING OR REMOVING CONNECTIONS

Always turn the power OFF prior to connecting or disconnecting cables. This is important to prevent damage to the unit itself as well as other connected equipment.

## 5. HANDLE CABLES CAREFULLY

Always plug and unplug cables – including the AC cord – by gripping the connector, not the cord.

## 6. CLEAN WITH A SOFT DRY CLOTH

Never use solvents such as benzine or thinner to clean the unit. Wipe clean with a soft, dry cloth.

## 7. ALWAYS USE THE CORRECT POWER SOURCE

Make sure that the power source voltage specified on the rear panel matches your local AC mains supply. Also make sure that the AC mains supply can deliver more than enough current to handle all equipment used in your system.

## IMPORTANT NOTICE FOR THE UNITED KINGDOM

### Connecting the Plug and Cord

IMPORTANT. The wires in this mains lead are coloured in accordance with the following code:

BLUE : NEUTRAL  
BROWN : LIVE

As the colours of the wires in the mains lead of this apparatus may not correspond with the coloured markings identifying the terminals in your plug proceed as follows:

The wire which is coloured BLUE must be connected to the terminal which is marked with the letter N or coloured BLACK.

The wire which is coloured BROWN must be connected to the terminal which is marked with the letter L or coloured RED.

Making sure that neither core is connected to the earth terminal of the three pin plug.

\* This applies only to products distributed by YAMAHA - KEMBLE MUSIC (U.K.) LTD.

## WARNING: CHEMICAL CONTENT NOTICE!

The solder used in the manufacture of this product contains LEAD. In addition, the electrical/electronic and/or plastic (where applicable) components may also contain traces of chemicals found by the California Health and Welfare Agency (and possibly other entities) to cause cancer and/or birth defects or other reproductive harm.

DO NOT REMOVE ANY ENCLOSURE COMPONENTS! There are no user serviceable parts inside. All service should be performed by a service representative authorized by Yamaha to perform such service.

IMPORTANT MESSAGE: Yamaha strives to produce products that are both user safe and environmentally "friendly". We sincerely believe that our products meet these goals. However, in keeping with both the spirit and the letter of various statutes we have included the messages shown above and others in various locations in this manual.

\* This applies only to products distributed by YAMAHA CORPORATION OF AMERICA.

# OPERATION

## FRONT PANEL

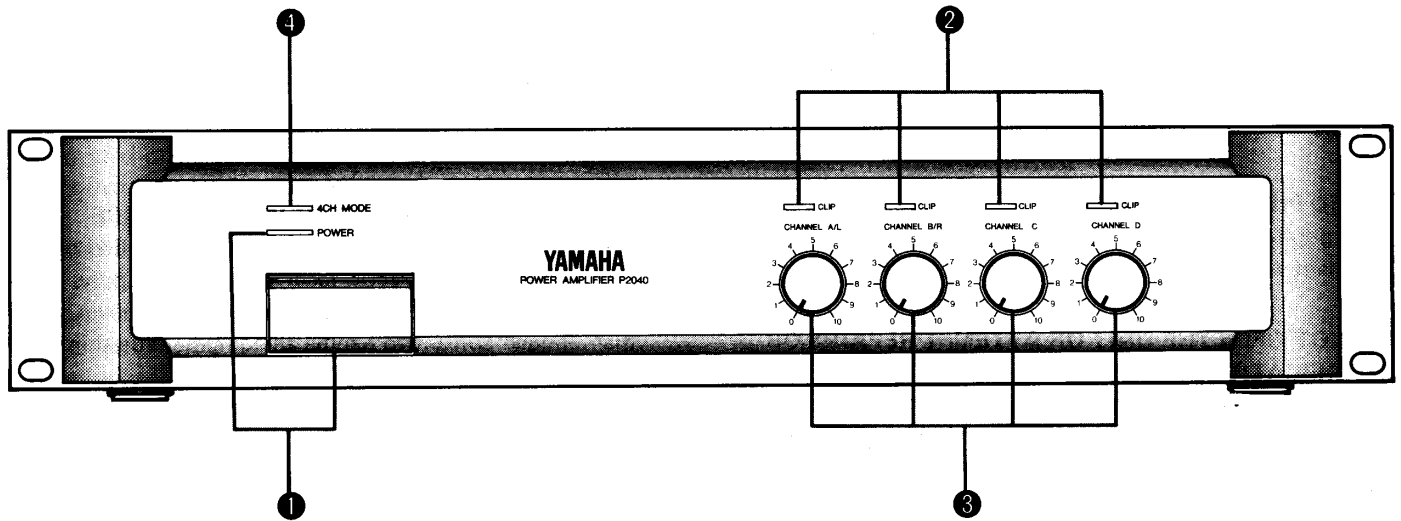

### ❶ POWER Switch & Indicator

Press the power switch in to turn power ON, and press again to turn the power OFF. The POWER LED immediately above the power switch will light when the power is ON.

#### CAUTION!

*The power amplifier should be the LAST piece of equipment turned on in any system. This is to avoid damage to the power amplifier and speakers due to power-surge "thumps" generated by turning on other equipment. The only exception to this rule is when the entire system is switched on simultaneously through a master power switch.*

### ❷ CLIP Indicators

Independent CLIP indicators are provided for channels A, B, C and D. They light when the output level of the corresponding channel reaches or exceeds clipping level: 27.2 dB (40 W/8 ohms) in the 2-channel mode, or 24.2 dB (20 W/8 ohms) in the 4-channel mode. Should any of the CLIP indicators light during amplifier operation — indicating clipping due to excessive signal levels — the input signal level should be decreased either at the source or by using the P2040 input attenuators.

### ❸ Input Attenuators

Independent input attenuators are provided for channels A, B, C and D. Rotated fully clockwise there is no attenuation, and thus maximum signal level. The maximum counter-clockwise setting provides infinity attenuation (i.e. channel OFF).

### ❹ 4CH MODE Indicator

This indicator lights when the rear-panel 2CH/4CH switch is set to the 4CH position, setting the P2040 to the 4-channel mode.

## REAR PANEL

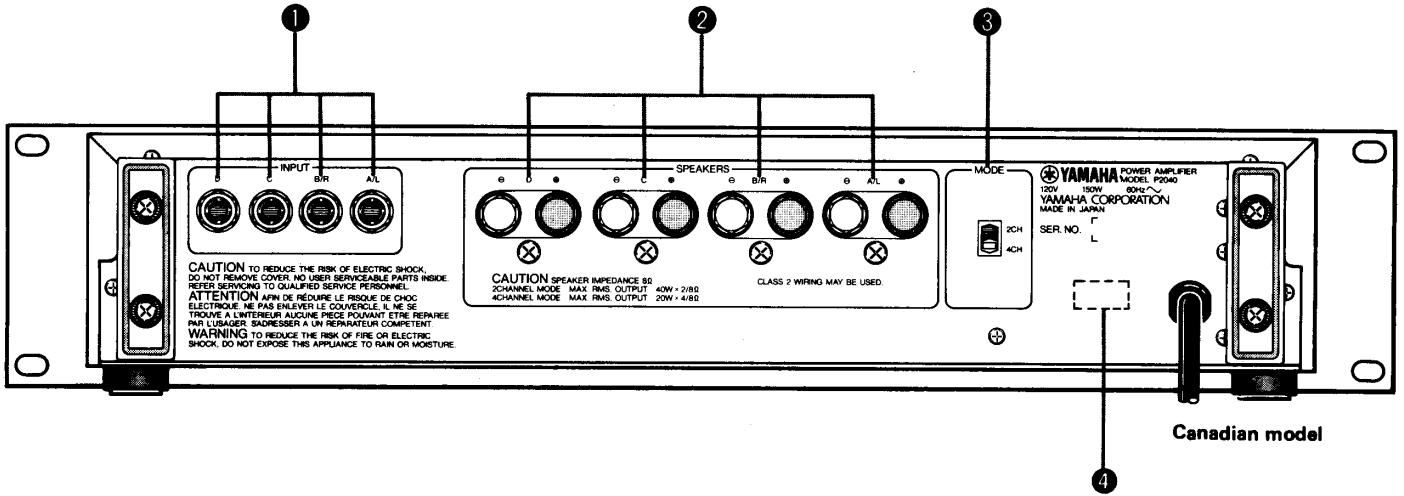

### ① INPUT Connectors

The A, B, C and D channel inputs are all unbalanced 1/4" phone jacks. Input sensitivity in the 2-channel mode is +2.2 dB (1.0 V), and in the 4-channel mode it is -0.8 dB (0.7 V).

### ② SPEAKER Output Terminals

For normal operation, the red or "+" speaker output terminals should be connected to the red or "+" terminals on the speakers and the black or "-" output terminals to the corresponding black or "-" terminals on the speakers. Unscrew the binding post terminals, insert the speaker wires, then securely tighten the terminals on the wires to ensure a good, reliable connection. Also make sure that no stray strands of wire can short out the speaker terminals.

#### NOTE!

*The minimum load impedance for each speaker output is 8 ohms. That means you can connect a single 8-ohm or 16-ohm speaker to each output, or a pair of 16-ohm speakers connected in parallel.*

### ③ 2CH/4CH MODE Switch

This switch sets the P2040 for operation in the 2-channel or 4-channel mode. Always make sure that the MODE switch is set to the correct position for the mode in which the P2040 is to be operated.

### ④ Voltage Selector (General model only)

Set this to your local AC mains voltage (220/240V AC). Failure to do so will result in seriously impaired performance or even severe damage.

## 4-CHANNEL OPERATION

- ① To set up for 4-channel operation, first make sure that the amplifier is OFF!
- ② Set the MODE switch to the 4CH position.
- ③ Connect the input sources to the CHANNEL A, B, C and D inputs.
- ④ Connect the four speakers to be used correctly to the appropriate speaker outputs.
- ⑤ Use the CHANNEL A, B, C and D input attenuators for sensitivity adjustment.

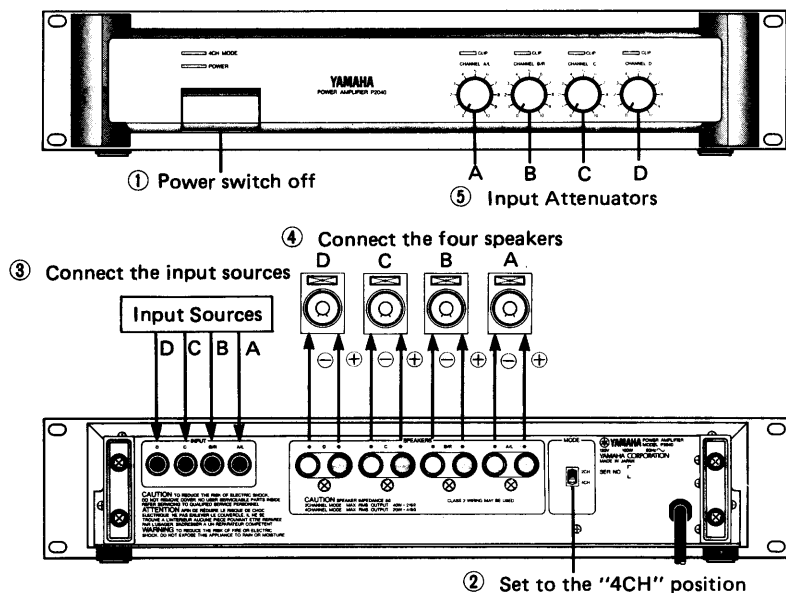

## 2-CHANNEL OPERATION

- ① To set up for 2-channel operation, first make sure that the amplifier is OFF!
- ② Set the MODE switch to the 2CH position.
- ③ Connect the stereo input source to the CHANNEL A (left) and B (right) inputs.
- ④ Connect the two speakers to be used correctly to the A (left) and B (right) speaker outputs.
- ⑤ Use only the CHANNEL A (left) and B (right) input attenuators for sensitivity adjustment.

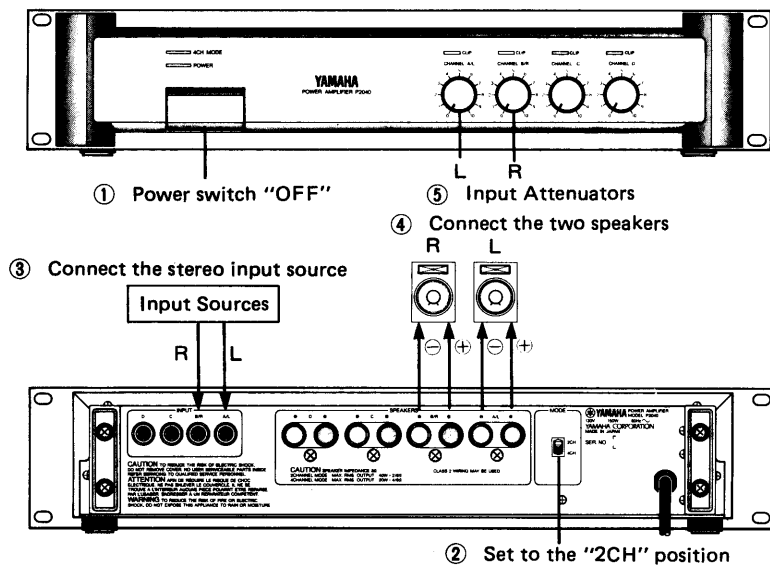

# MOUNTING

### Shelf Mounting

The P2040 can be used on any flat level surface as long as there is adequate ventilation. Do not remove the amplifier's feet as this would block cooling airflow.

### Rack Mounting

The P2040 can be mounted in any standard 19" electronic equipment rack. The rear panel of the rack should be left open to promote smooth airflow. Cooling fans may be required for rack-mounted P2040's if they must produce consistently high average power output in a closed rack space.

# GENERAL SPECIFICATIONS

## POWER OUTPUT LEVEL

2-CHANNEL: 40W x 2, RL=8 ohms, f=20–20 kHz, THD ≤ 0.05%  
 4-CHANNEL: 20W x 4, RL=8 ohms, f=20–20 kHz, THD ≤ 0.07%

## FREQUENCY RESPONSE

±0.5 dB, F=20 Hz–20 kHz, RL=8 ohms, Po=1W

## POWER BANDWIDTH (≤ 0.18% THD)

2-CHANNEL: 10 Hz – 50 kHz, Po=20W, RL=8 ohms  
 4-CHANNEL: 10 Hz – 40 kHz, Po=10W, RL=8 ohms

## TOTAL HARMONIC DISTORTION

2-CHANNEL: ≤ 0.08%, Po=20W, f=20 Hz–20 kHz, RL=8 ohms  
 4-CHANNEL: ≤ 0.1%, Po=10W, f=20 Hz–20 kHz, RL=8 ohms

## INTERMODULATION DISTORTION (70 Hz: 7 kHz = 4 : 1)

2-CHANNEL: ≤ 0.08%, Po=20W, RL=8 ohms  
 4-CHANNEL: ≤ 0.1%, Po=10W, RL=8 ohms

## CHANNEL SEPARATION

2-CHANNEL: ≥ 70 dB, f=1 kHz  
 4-CHANNEL: ≥ 60 dB, f=1 kHz

## DAMPING FACTOR

≥ 70, f=1 kHz, RL=8 ohms

## SIGNAL-TO-NOISE RATIO

2-CHANNEL: ≥ 117 dB, INPUT short, IHF-A  
 4-CHANNEL: ≥ 114 dB, INPUT short, IHF-A

## RESIDUAL NOISE

≤ -86 dBm, ATT min., @ fc=12.7 kHz 6 dB/oct LPF  
 ≤ -90 dBm, ATT min., @ IHF-A Network

## SLEW RATE

10 V/μS, RL=8 ohms, full swing

## SENSITIVITY

2-CHANNEL: +2.2 dBm (1.0 V), Po=40W, RL=8 ohms, f=1 kHz  
 4-CHANNEL: -0.8 dBm (0.7 V), Po=20W, RL=8 ohms, f=1 kHz

## VOLTAGE GAIN

25 dB, ATT. max., f=1 kHz

## INPUT IMPEDANCE

≥ 20 k-ohms

## INDICATORS

Clip: Red LED  
 Pilot: Red LED, power ON  
 4ch Mode: Green LED, Lights when the 4-channel mode is active.

## PROTECTION CIRCUITS

Muting: 4 ± 3 sec. after power turned ON  
 DC Sense: DC ± 3 V output voltage  
 Over-current: ON when speaker short @ 1 kHz, 10W

## CONTROLS

Front: Push-ON/Push-OFF POWER switch  
 Attenuators x 4  
 (only CH A and B function during 2CH operation)  
 Rear: 2CH/4CH mode switch

## POWER REQUIREMENTS

General model: 220/240 VAC, 50/60 Hz  
 Canadian model: 120 VAC, 60 Hz

## POWER CONSUMPTION

General model: 150W  
 Canadian model: 150W

## DIMENSIONS (W x H x D)

480 mm x 90 mm x 337 mm  
 (18-7/8" x 3-1/2" x 13-1/4")

## WEIGHT

6.5 kilograms (14.3 lbs.)

• All specifications subject to change without notice.

## FREQUENCY RESPONSE CHARACTERISTICS

Load Impedance: 8Ω      Mode: 4ch  
 Input Attenuators: Max      0dB = 1W/8Ω

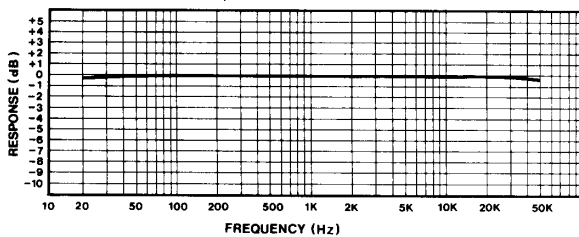

## THD vs OUTPUT POWER CHARACTERISTICS

Load Impedance: 8Ω      Mode: 2ch

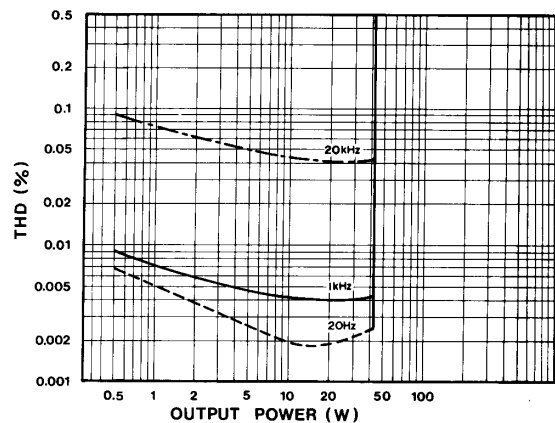

## THD vs OUTPUT POWER CHARACTERISTICS

Load Impedance: 8Ω      Mode: 4ch

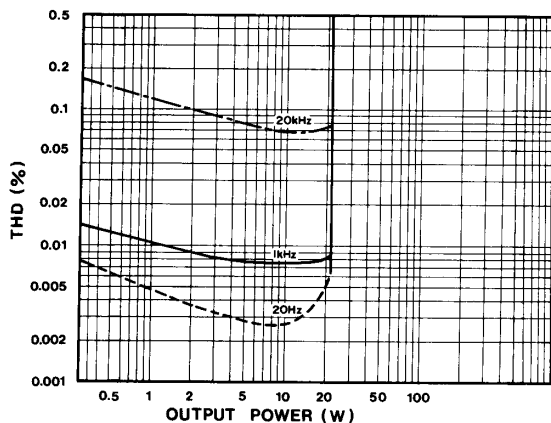

## • For European Model

Purchaser/User information specified in EN55103-1 and EN55103-2.

Inrush Current: 5A

Conformed Environment: E1, E2, E3 and E4.

# BLOCK DIAGRAM

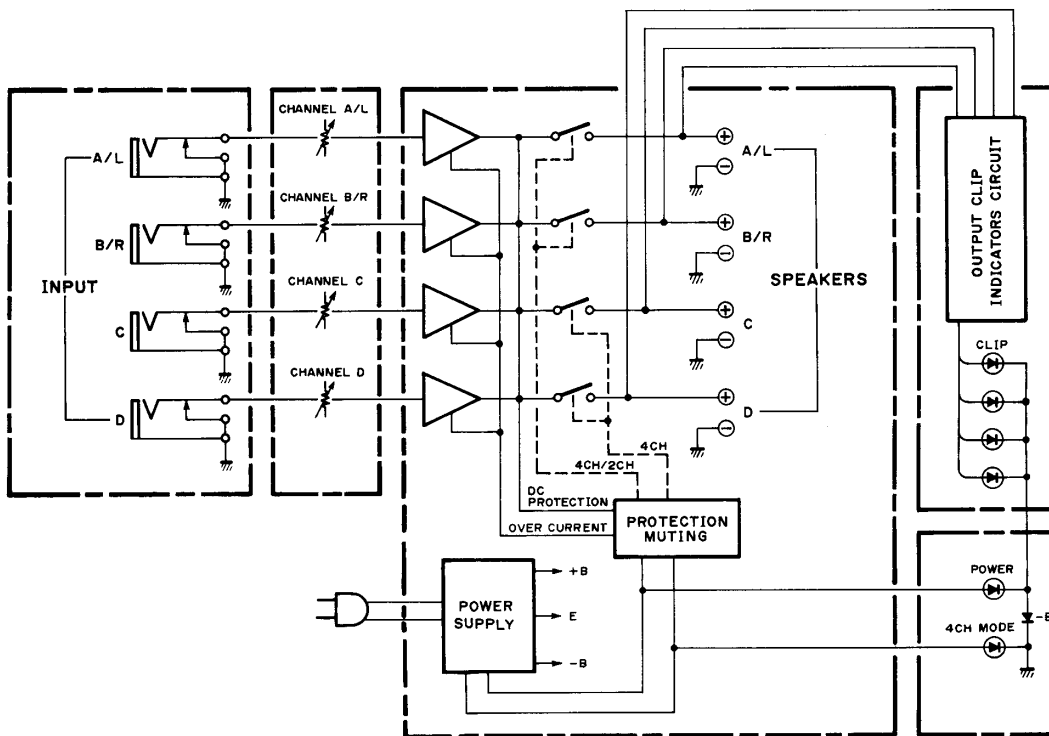

# DIMENSIONS

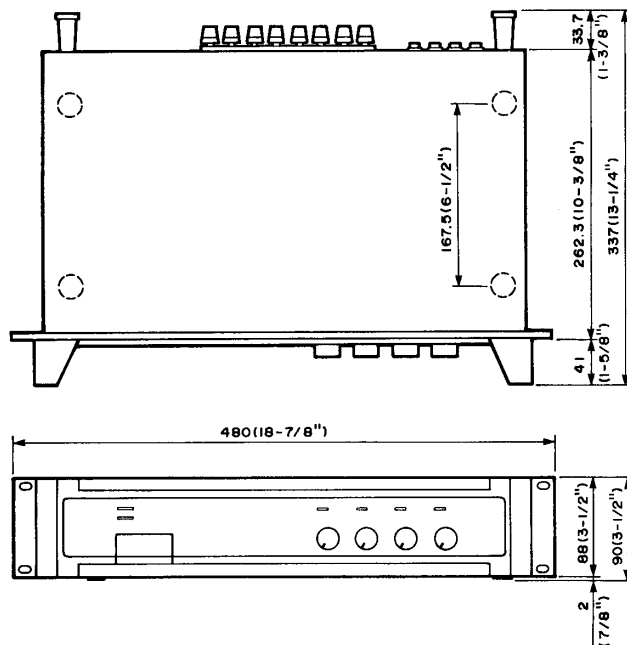

Unit: mm (Inch)

## SERVICE

This product is supported by Yamaha's worldwide network of factory trained and qualified dealer service personnel. In the event of a problem, contact your nearest Yamaha dealer.